

Powered by



# EVX 12170 ▶ 12V 17Ah

EVX 12170 is designed specially for electric vehicles, such as electric golf cart, electric wheelchair, mower, dust collector...etc. It has high cycling life, high efficiency and long service life.



## ► Specification

Cells Per Unit	6
Voltage Per Unit	12
Capacity	17Ah @ 20hr-rate to 1.75V per cell @25 °C (77°F)
Weight	Approx. 5.67 kg (12.5 lbs)
Maximum Discharge Current	230A(5sec)
Internal Resistance	Approx. 16.5 mΩ
Operating Temperature Range	Discharge: -15°C~50°C ( 5°F~122°F) Charge: -15 °C~40°C ( 5°F~104°F) Storage: -15°C~40°C ( 5°F~104°F)
Nominal Operating Temperature Range	25°C±3°C (77°F±5°F)
Float Charging Voltage	13.5 to 13.8 VDC/unit Average at 25°C (77°F)
Recommended Maximum Charging Current Limit	5.1A
Equalization and Cycle Service	14.4 to 15.0 VDC/unit Average at 25°C (77°F)
Self Discharge	CSB Batteries can be stored for more than 6 months at 25°C (77°F). Please charge batteries before using. For higher temperatures the time interval will be shorter.
Terminal	B1/B3-L terminal to accept M5 nut & bolt
Container Material	ABS(UL 94-HB/File E50263)*Flammability resistance of (UL 94-V0/File E88637) can be available upon request.



CSB-manufactured VRLA batteries are UL-recognized components under UL924 and UL1989.

CSB is also certified by ISO 9001 and ISO 14001.

## ► Dimensions :

Unit: mm (inch)	Overall Height (H)	Container height (h)	Length (L)	Width (W)
	167±2 (6.57±0.08)	165.5±2 (6.51±0.08)	181±2 (7.13±0.08)	76.2±1 (3.0±0.04)

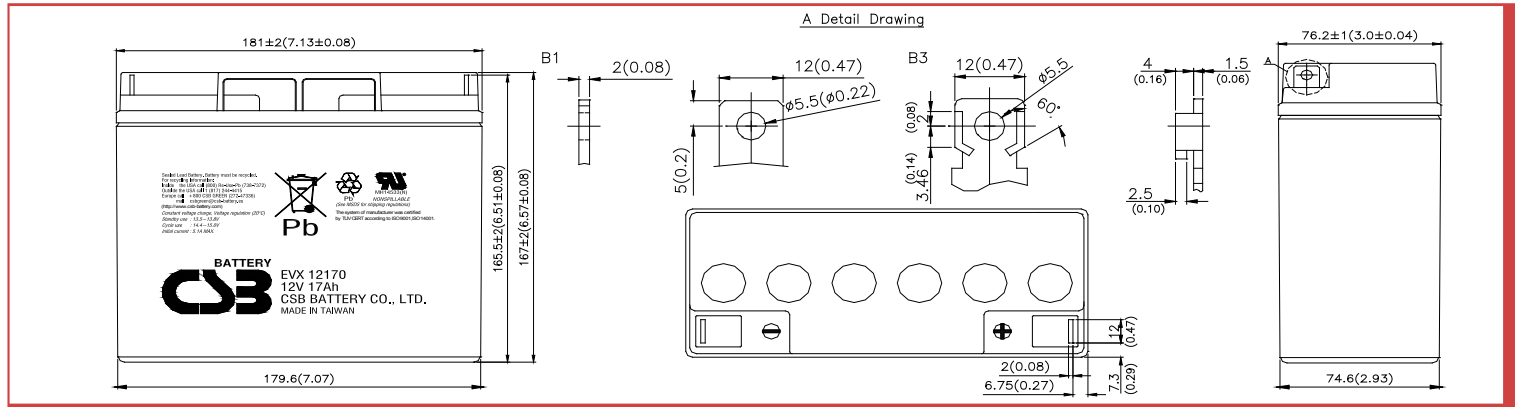

## Constant Current Discharge Characteristics Unit:A (25°C ,77°F)

F.V/Time	30MIN	60MIN	90MIN	2HR	3HR	4HR	5HR	8HR	10HR	20HR
1.60V	17.0	10.3	7.34	5.94	4.43	3.55	2.92	1.98	1.63	0.925
1.67V	16.5	9.94	7.14	5.77	4.28	3.43	2.84	1.92	1.58	0.904
1.70V	16.0	9.67	6.91	5.62	4.16	3.34	2.76	1.87	1.54	0.875
1.75V	15.5	9.38	6.70	5.43	4.04	3.24	2.68	1.81	1.49	0.850
1.80V	15.0	9.08	6.48	5.25	3.91	3.14	2.59	1.75	1.44	0.825
1.85V	14.5	8.79	6.27	5.09	3.79	3.04	2.51	1.69	1.39	0.800

## Constant Power Discharge Characteristics Unit:W (25°C ,77°F)

F.V/Time	30MIN	60MIN	90MIN	2HR	3HR	4HR	5HR	8HR	10HR	20HR
1.60V	204	123	88.1	71.6	53.1	42.6	35.0	23.8	19.6	10.8
1.67V	198	120	85.5	69.5	51.3	41.3	34.1	23.1	18.8	10.4
1.70V	192	116	82.9	67.9	49.9	40.1	33.1	22.4	18.5	10.2
1.75V	186	113	80.4	65.5	48.4	38.9	32.1	21.7	17.9	9.90
1.80V	180	109	77.8	63.3	46.9	37.7	31.1	21.0	17.3	9.59
1.85V	174	106	75.3	61.4	45.4	36.5	30.1	20.3	16.7	9.29

### Trickle (or Float) Service Life

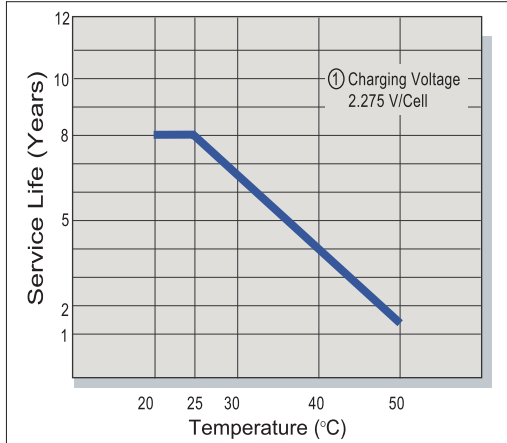

### Capacity Retention Characteristic

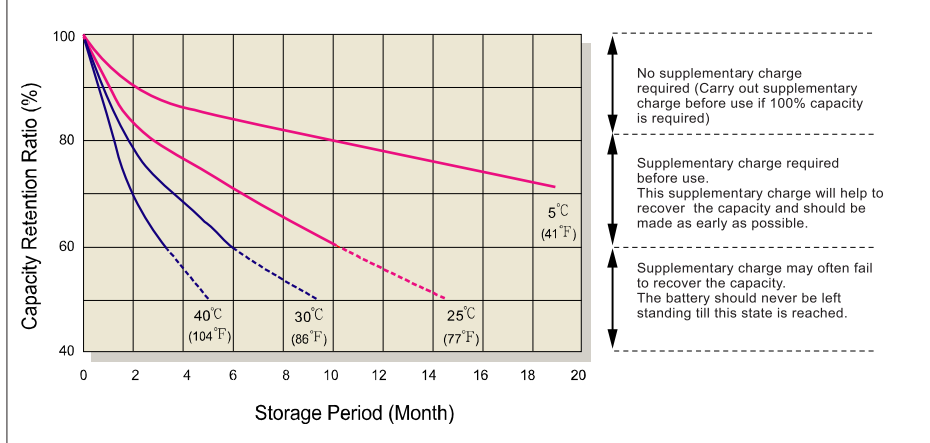

### Battery Voltage and Charge Time for Standby Use

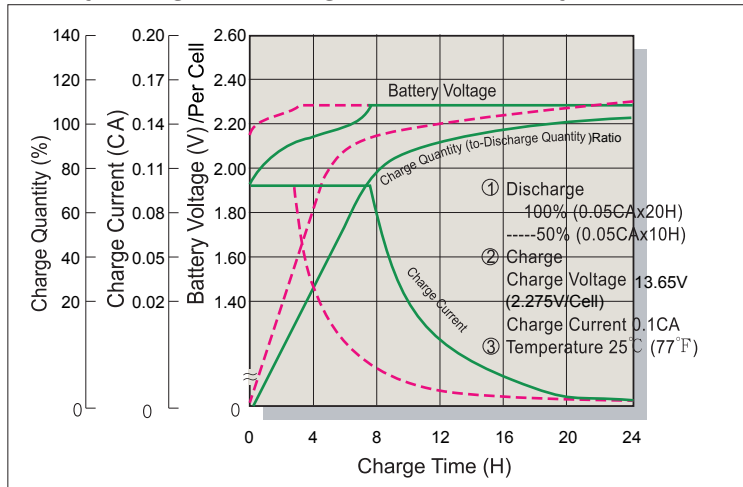

### Series Cycle Service Life

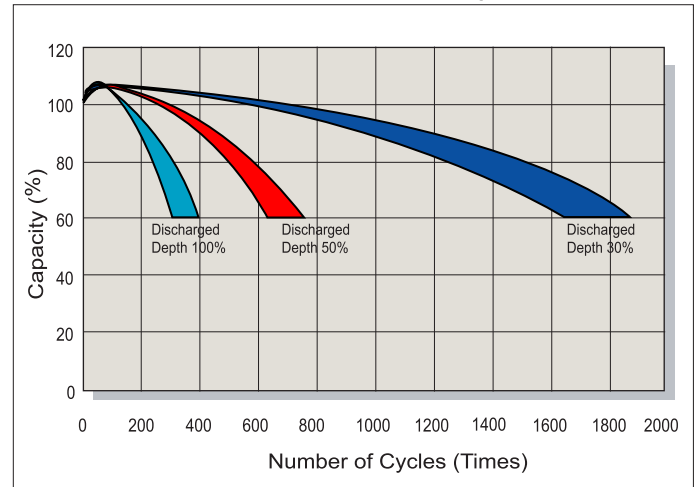

### Battery Voltage and Charge Time for Cycle Use

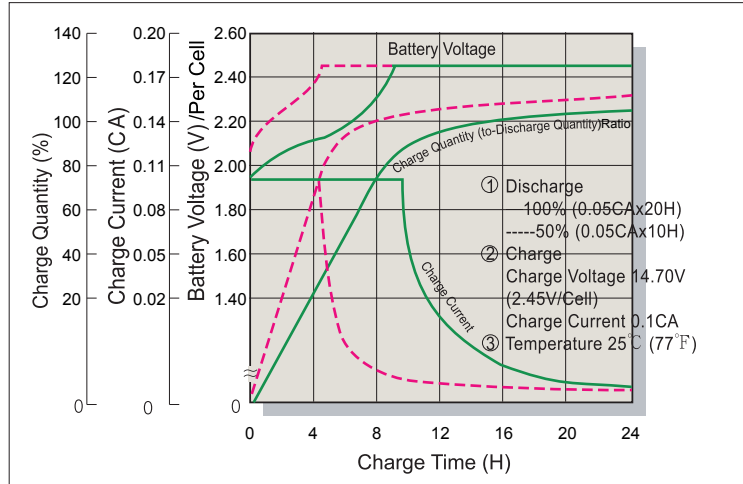

### Terminal Voltage (V) and Discharge Time

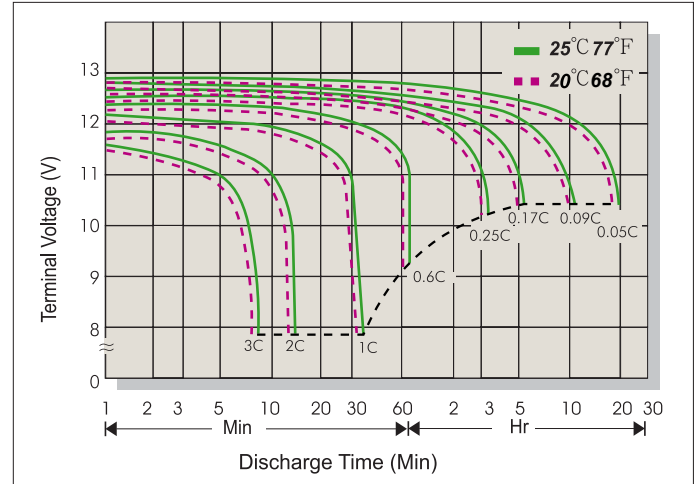

### Charging Procedures

Application	Charge Voltage(V/Cell)			Max.Charge Current
	Temperature	Set Point	Allowable Range	
Cycle Use	25°C(77°F)	2.45	2.40~2.50	0.3C
Standby	25°C(77°F)	2.275	2.25~2.30	

### Discharge Current VS. Discharge Voltage

Final Discharge Voltage V/Cell	1.75	1.70	1.60	1.30
Discharge Current(A)	0.2C>(A)	0.2C<(A)<0.5C	0.5C<(A)<1.0C	(A)>1.0C

Sales Office URL: [WWW.CSB-BATTERY.COM](http://WWW.CSB-BATTERY.COM)

**GLOBAL HQ**  
**CSB BATTERY CO., LTD. (TAIWAN)**  
 Tel : +886-2-2555-5600  
 Fax : +886-2-2555-3300  
 mail : service@csb-battery.com.tw

**BEIJING OFFICE. (CHINA)**  
**CSB BATTERY TECHNOLOGIES (BEIJING) CO., LTD.**  
 Tel : +86-10-59621300/1301/1302/1303  
 Fax : +86-10-59621304  
 mail : chinasl@csb-battery.com

**AMERICA HQ**  
**CSB BATTERY TECHNOLOGIES INC. (U.S.A)**  
 Tel : +1-817-244-7777/1-(800)3-CSB-USA(272872)  
 Fax : +1-817-244-4445  
 mail : csb@csb-battery.com

**SHANGHAI OFFICE. (CHINA)**  
**CSB BATTERY LOGISTIC (SHANGHAI) CO., LTD.**  
 Tel : +86-21-5046-1622/5046-0833  
 Fax : +86-21-5064-3314  
 mail : chinasl@csb-battery.com

**EUROPE HQ**  
**CSB Battery Europe BV.**  
 Tel : +31(0)-180-418-140  
 Fax : +31(0)-180-418-327  
 mail : eurosales@csb-battery.eu

**SHENZHEN OFFICE. (CHINA)**  
**CSB BATTERY LOGISTIC (SHANGHAI) CO., LTD.**  
 Tel : +86-755-8831-6488/6396/6356  
 Fax : +86-755-8831-6548  
 mail : she@csb-battery.com.cn