

Technical specification

Winston LFP100AHA TALL cell

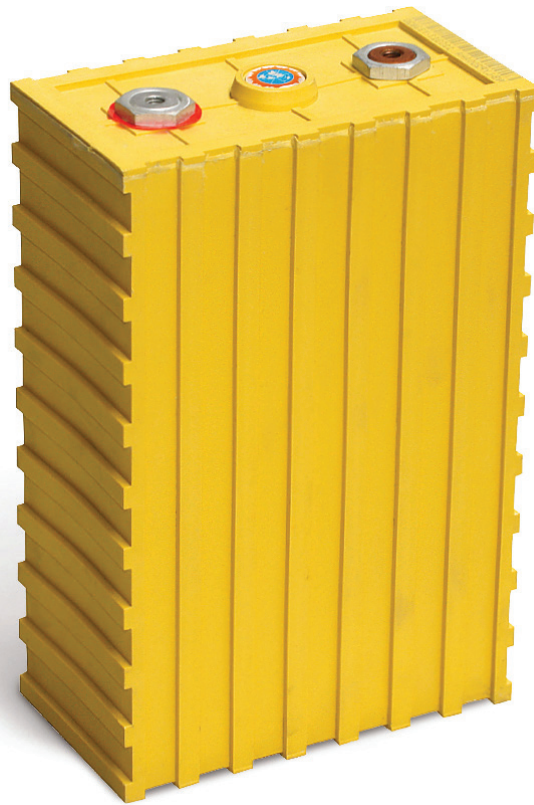

PRODUCT WEBPAGE



Winston LFP100AHA TALL cell

Specifications		
Model name	LFP100AHA TALL	Alternative product mark TS-LFP100AHA, WB-LYP100AHA(A)
Nominal voltage	3.3 V	Operating voltage under load is 3.0 V
Capacity	100 AH	+/- 5%
Operating voltage	max 4.0V - min 2.8V	At 80% DOD
Deep discharge voltage	2.5 V	The cells is damaged if voltage drops bellow this level
Maximal charge voltage	4 V	The cells is damaged if voltage exceeds this level
Optimal discharge current	< 50 A	0.5 C
Maximal discharge current	< 300 A	3 C, continuous for max 15 minutes from full charge
Max peak discharge current	< 1000 A	10 C, maximal 5 seconds in 1 minute
Optimal charge current	< 50 A	0.5 C
Maximal charge current	< 300 A	< 3 C with battery temperature monitoring
Maximal continuous operating temperature	80 °C	The battery temperature should not increase this level during charge and discharge
Dimensions	143 X 218 X 67	Millimeters (tolerance +/- 2 mm)
Weight	3.3 kg	Kilograms (tolerance +/- 150g)
Optimal torque force	20 - 22 Nm	

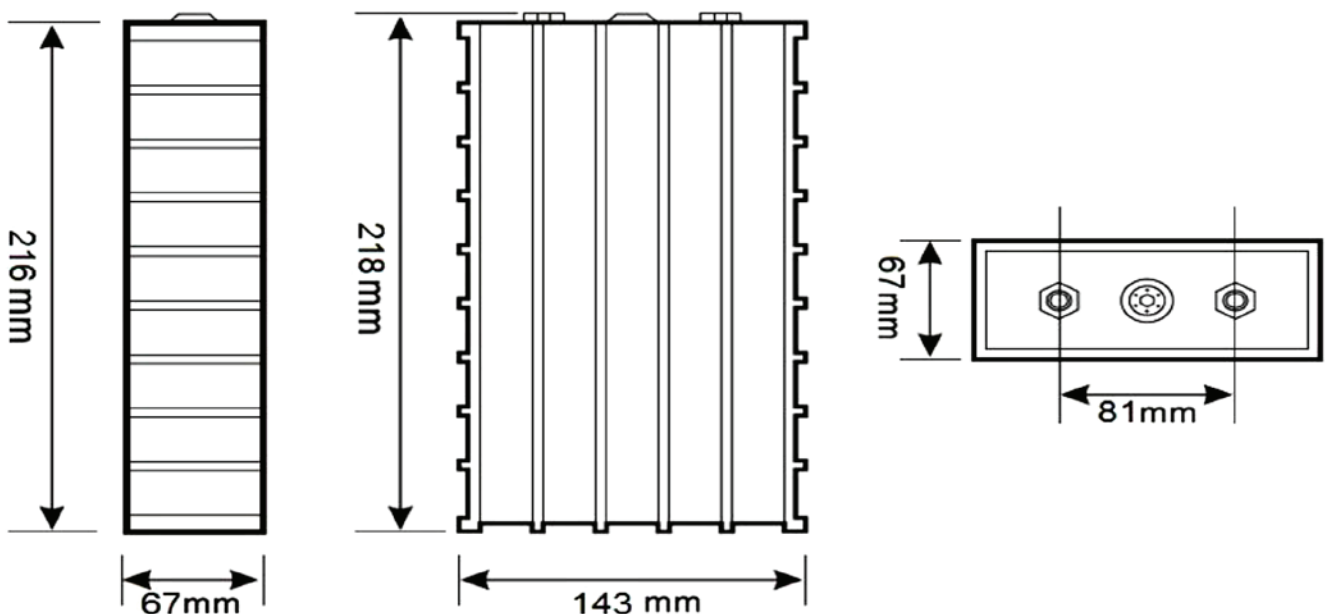

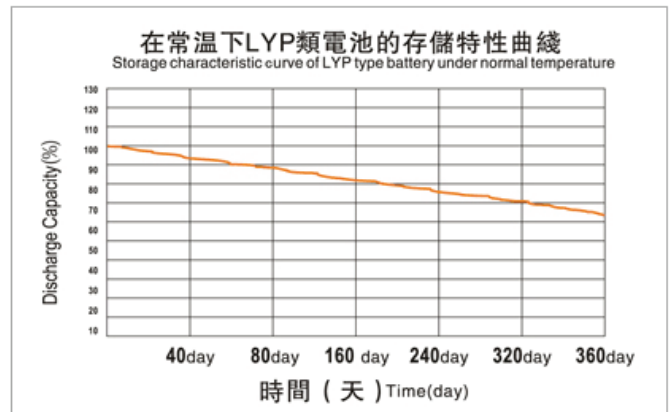
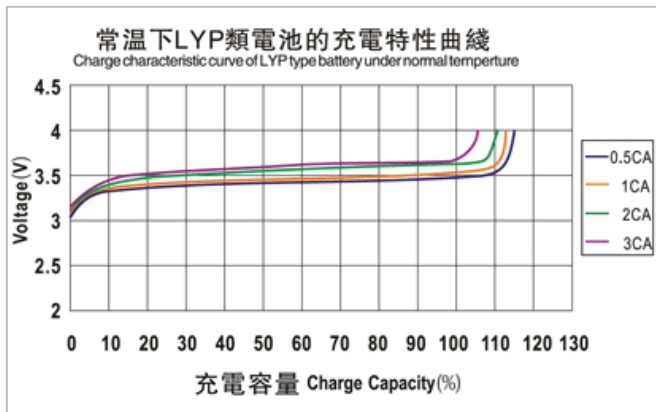
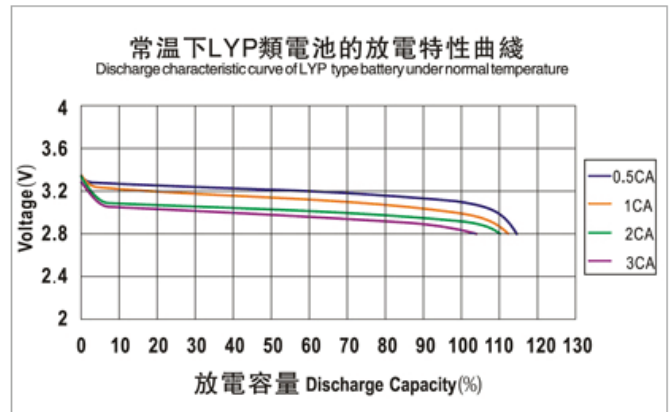
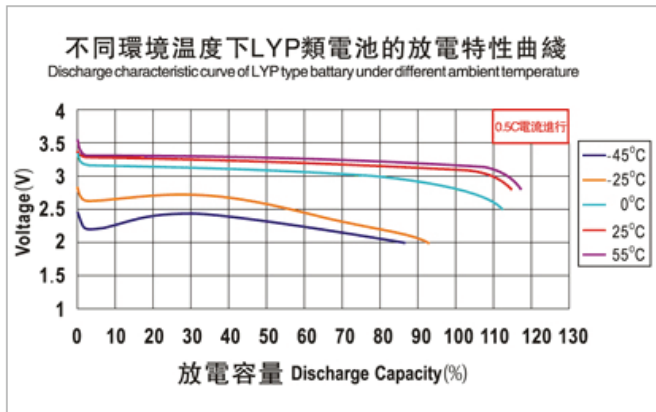

 **PRODUCT WEBPAGE** >



GWL a.s.
Průmyslová 11, 102 00 Prague 10
Czech Republic, European Union